

- (1) 3706D-10 – FRONT LOADING
- (10) 'MB1' DOORS
- (1) 'OM2' OUTGOING MAIL COMPARTMENT

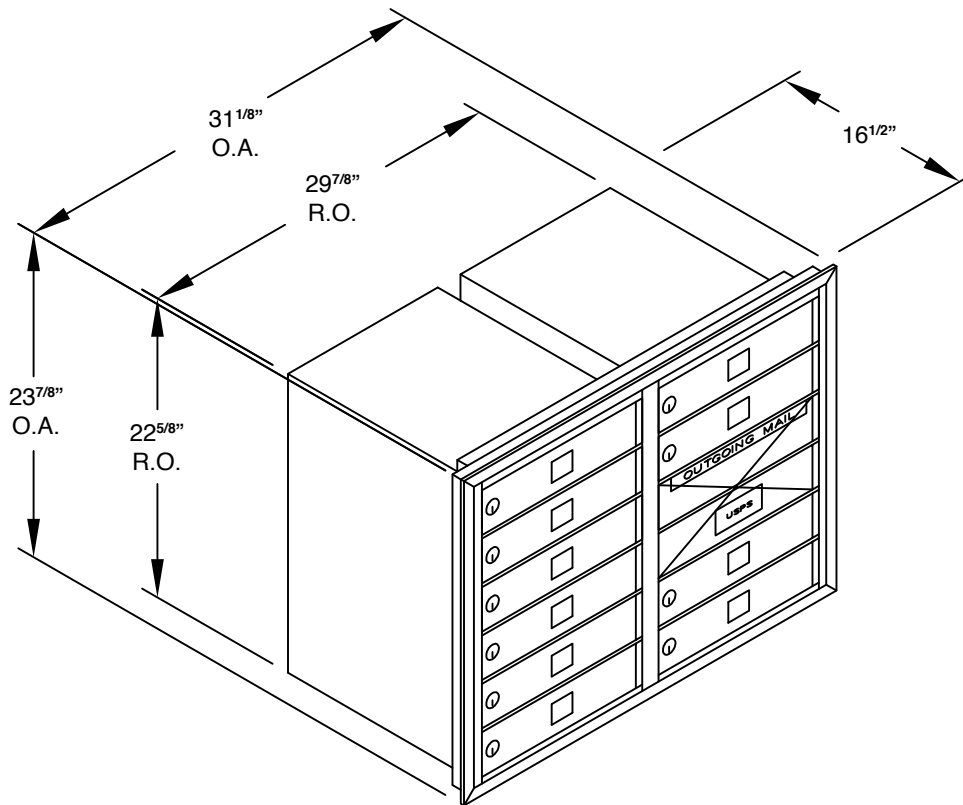

- (1) 3706D-10 - REAR LOADING
- (10) 'MB1' DOORS
- (1) 'OM2' OUTGOING MAIL COMPARTMENT